

# MASTERVOLT

THE POWER TO BE INDEPENDENT

## Mac Plus

BI-DIRECTIONAL DC-DC CHARGER

48/12-50, 12/48-15, 48/24-30, 24/48-15



**CZONE**<sup>®</sup>

### USER AND INSTALLATION MANUAL

- (EN) For the latest version of this manual, visit our website:
- (NL) Ga om deze handleiding in andere talen te downloaden naar onze website:
- (DE) Um diese Anleitung in anderen Sprachen herunterzuladen, besuchen Sie bitte unsere Website:
- (FR) Pour télécharger ce manuel dans d'autres langues, consultez notre site Web :
- (ES) Para descargar este manual en otros idiomas, visite nuestro sitio web:
- (IT) Per scaricare questo manuale in altre lingue, visitare la pagina del prodotto sul nostro sito Web:

[www.mastervolt.com](http://www.mastervolt.com)

## TABLE OF CONTENTS

|   |           |   |           |
|---|-----------|---|-----------|
| <b>1. Safety Instructions.....</b>                                  | <b>3</b>  |   |           |
| Warnings and symbols .....  | 3         |   |           |
| General .....   | 3         |   |           |
| Explosive gases .....   | 4         |   |           |
| Warnings regarding the use of batteries ..                          | 4         |   |           |
| Warning regarding life support applications .....                   | 5         |   |           |
| <b>2. General Information.....</b>                                  | <b>6</b>  |   |           |
| Use of this manual.....   | 6         |   |           |
| Liability .....   | 6         |   |           |
| Warranty.....   | 6         |   |           |
| Disclaimer .....  | 6         |   |           |
| Identification label.....   | 7         |   |           |
| Correct disposal of this product .....                              | 7         |   |           |
| <b>3. Product Description.....</b>                                  | <b>8</b>  |   |           |
| Dimensions.....   | 9         |   |           |
| Front panel .....   | 10        |   |           |
| <b>4. Installation Instructions .....</b>                           | <b>11</b> |   |           |
| <b>5. Placement and Mounting .....</b>                              | <b>12</b> |   |           |
| <b>6. Connection .....</b>  | <b>13</b> |   |           |
| Installation A – the Mac Plus as a Battery charger .....            | 13        |   |           |
| Installation B – the Mac Plus as a stabilized DC power supply ..... | 13        |   |           |
| Remote switch input (pin 4) .....                                   | 14        |   |           |
| Battery temperature sensor (pins 5 & 6)                             | 14        |   |           |
| Voltage drop compensation (pins 1 & 2)                              | 15        |   |           |
| Optional 'reverse charge direction'-switch (pin 3) .....            | 16        |   |           |
|   |           | Adding the Mac Plus to a MasterBus network .....          | 16        |
|   |           | Adding the Mac Plus to a CZone network .....              | 16        |
|   |           | <b>7. Configuration – DIP Switches .....</b>              | <b>17</b> |
|   |           | <b>8. Operation .....</b>                                 | <b>19</b> |
|   |           | LED indicators.....                                       | 19        |
|   |           | Operating modes .....                                     | 20        |
|   |           | Bi-directional operation .....                            | 22        |
|   |           | Flat battery support .....                                | 22        |
|   |           | <b>9. MasterBus .....</b>                                 | <b>23</b> |
|   |           | What is MasterBus.....                                    | 23        |
|   |           | MasterBus on the Mac Plus .....                           | 23        |
|   |           | Monitoring .....  | 24        |
|   |           | Alarm.....  | 25        |
|   |           | Configuration.....  | 25        |
|   |           | Events .....  | 29        |
|   |           | <b>10. CZone.....</b>                                     | <b>31</b> |
|   |           | What is CZone .....                                       | 31        |
|   |           | Adding the Mac Plus to a CZone system configuration ..... | 31        |
|   |           | <b>11. Trouble Shooting.....</b>                          | <b>35</b> |
|   |           | <b>12. Technical Specifications.....</b>                  | <b>37</b> |
|   |           | Mac Plus Specifications .....                             | 37        |
|   |           | CZone specifications.....                                 | 38        |
|   |           | Battery settings .....                                    | 38        |
|   |           | Characteristics .....                                     | 39        |

## 1. Safety Instructions

This chapter describes important safety and operating instructions for use of a Mac Plus in residential, vehicle (RV) and marine applications.

### READ AND SAVE THESE INSTRUCTIONS

#### Warnings and symbols

Safety instructions and warnings are marked in this manual and on the product by the following pictograms:



#### CAUTION!

Special information, commands and prohibitions in order to prevent damage.



#### CAUTION!

The addition of this symbol to a caution indicates that the surface may be warm.



#### WARNING!

A WARNING refers to possible injury to the user or installer or significant material damage to the Mac Plus if the installer / user does not (carefully) follow the stated procedures.

#### General

- 1 Before using the Mac Plus, read all instructions and cautionary markings on the Mac Plus, the batteries, and all appropriate sections of the manual.
- 2 To reduce the risk of electric shock – Do not expose the Mac Plus to rain, snow, spray, moisture, excessive pollution and condensing circumstances. To reduce risk of fire hazard, do not cover or obstruct the ventilation openings. Do not install the Mac Plus in a poorly ventilated room, this may result in overheating.
- 3 Use of an attachment or spare part, not recommended or sold by Mastervolt, may result in a risk of fire, electric shock, or injury to persons.
- 4 The Mac Plus is designed to be permanently connected to a DC electrical system. Installation of, and work on the Mac Plus, may be carried out only by a qualified, authorized and trained technician or electrician, consistent with the locally applicable standards and regulations.
- 5 Make sure that all wiring is properly installed and in good electrical condition; and that wire size is large enough for DC current rating of the Mac Plus. Check the wiring on a regular base, at least once a year. Do not use the Mac Plus when the wiring is undersized or damaged. Replace damaged wires immediately.
- 6 Do not operate the Mac Plus if it has received a sharp blow, been dropped, or otherwise damaged in any way; take it to a qualified service technician.

- 7 Except for the connection compartment, the Mac Plus may not be opened or disassembled. There are no serviceable parts inside the cabinet. Take it to a qualified, authorized and trained service technician when service or repair is required. Incorrect reassembly may result in a risk of electric shock or fire.
- 8 To reduce risk of electric shock, disconnect the Mac Plus from the DC electrical system before attempting any maintenance or cleaning. Turning off controls will not reduce this risk.
- 9 The Mac Plus may not be used by children or by those who cannot read and understand the manual if they are not supervised by a responsible person who can guarantee that the charger is being used in a safe manner. Keep the charger away from children.
- 10 Short circuiting or reversing polarity will lead to serious damage to batteries, Mac Plus, wiring as well as accessories. Fuses cannot prevent damage caused by reversed polarity and the warranty will be void.
- 11 In case of fire, you must use the fire extinguisher which is appropriate for electrical equipment.
- 12 If applied in a marine application in the United States, external connections to the Mac Plus shall comply with the United States Coast Guard Electrical Regulations (33CFR183, Sub part I).

### Explosive gases

- 1 **WARNING – WORKING IN VICINITY OF A LEAD-ACID BATTERY IS DANGEROUS. BATTERIES GENERATE EXPLOSIVE GASES DURING NORMAL BATTERY OPERATION. FOR THIS REASON, IT IS OF UTMOST IMPORTANCE THAT EACH TIME BEFORE USING THE Mac Plus, YOU READ THIS MANUAL AND FOLLOW THE INSTRUCTIONS EXACTLY.**
- 2 To reduce risk of battery explosion, follow these instructions and those published by battery manufacturer and manufacturer of any equipment you intend to use in vicinity of the battery. Review cautionary marking on these products.
- 3 **DANGER:** To reduce the risk of explosion – Never use the Mac Plus in situations where there is danger of gas or dust explosion.

### Warnings regarding the use of batteries

- 1 Someone should be within range of your voice or close enough to come to your aid when you work near a battery.
- 2 Have plenty of fresh water and soap nearby in case battery acid contacts skin, clothing, or eyes.
- 3 Wear complete eye protection and clothing protection. Avoid touching eyes while working near battery.
- 4 If battery acid contacts skin or clothing, wash immediately with soap and water. If acid enters eye, immediately flood eye with running cold water for at least 10 minutes and get medical attention immediately.
- 5 NEVER smoke or allow a spark or flame in vicinity of battery or engine.

- 6 Do not short circuit batteries, as this may result in explosion and fire hazard! Be extra cautious to reduce risk of dropping a metal tool onto a battery. It might spark or short-circuit battery or other electrical part that may cause explosion.
- 7 Remove personal metal items such as rings, bracelets, necklaces, and watches when working with a battery. A battery can produce a short-circuit current high enough to weld a ring or the like to metal, causing a severe burn.
- 8 Do not use Mac Plus for charging non-rechargeable batteries that are commonly used with home appliances. These batteries may burst and cause injury to persons and damage to property.
- 9 NEVER charge a frozen battery.
- 10 Excessive battery discharge and/or high charging voltages can cause serious damage to batteries. Do not exceed the recommended limits of discharge level of your batteries.
- 11 If it is necessary to remove a battery, always remove grounded terminal from battery first. Make sure all accessories are off, so as not to cause an arc.
- 12 Be sure that the area around battery is well ventilated while battery is being charged. Refer to the recommendations of the battery manufacturer.
- 13 Batteries are heavy! It may become a projectile if it is involved in an accident! Ensure adequate and sure mounting and always use suitable handling equipment for transportation.

#### **Warning regarding life support applications**

Do not use the Mac Plus for applications in any medical equipment intended for use as a component of a life support system. For this type of use a specific written agreement between the customer and Mastervolt is required.

## 2. General Information

### Use of this manual

This manual serves as a guideline for the safe and effective operation and maintenance of the following Mac Plus models:

| Product code | Model             |
|--------------|-------------------|
| 81203105     | Mac Plus 48/12-50 |
| 81203205     | Mac Plus 12/48-15 |
| 81203305     | Mac Plus 48/24-30 |
| 81203405     | Mac Plus 24/48-15 |

These models are further referred to as “Mac Plus”.

### Liability

Mastervolt can accept no liability for:

- Consequential damage resulting from the use of the Mac Plus.
- Possible errors in the included manual and the consequences of these.
- Use that is inconsistent with the purpose of the product.

### Warranty

The Mastervolt product warranty covers the Mac Plus for the first two years after the purchase date, on the condition that the product is installed and used according to the instructions in this manual. Installation or use that do not comply with these instructions may result in under performance, damage or failure of the product and may void this warranty. The warranty is limited to the cost of repair and/or replacement of the product. Costs of labor or shipping are not covered by this warranty.

### Disclaimer

Our products are subject to continual development and improvement. Therefore, additions or modifications to the products may cause changes to the technical data and functional specifications. No rights can be derived from this document. Please consult our most current Terms & Conditions of Sale.

### Identification label

Important technical information required for service, maintenance & secondary delivery of parts can be derived from the identification label. The following picture is only an example!

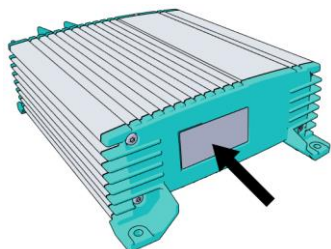

Part no: 81203105

Type: Mac Plus 48/12 - 50

High: 48Vdc, 15A dc

Low: 12Vdc, 50A dc



IP23



Serial no: R221A1000

UK: 2 Enterprise Road, Bangor BT19 7TA

EU: Snijdersbergweg 93, 1105 AN, Amsterdam, NL

Made in the PRC

(Serial number R221A1000 with device hardware version A)



### CAUTION!

Never remove the identification label. This will void the warranty.

### Correct disposal of this product



This product is designed and manufactured with high quality materials and components, which can be recycled and reused. Act according to your local rules and do not dispose of your old products with your normal household waste. The correct disposal of your old product will help prevent potential negative consequences to the environment and human health.

### 3. Product Description

The Mac Plus charger converts a DC (battery) voltage to a regulated DC voltage. The left side is the high side (36/48V) and the right side is the low side (12/24V). The Mac Plus can use each side as input or output. The default direction of the current flow is indicated by the product name. So a Mac Plus 48/12-50 uses the 48V as input and the 12V as output. Selection of the direction of the current flow is controlled through MasterBus event configuration, CZone circuit configuration, or a remote switch. Reversing the charge direction is typically used for boosting the starter battery.

Application examples:

- situations where the electrical power system voltage is 48V but the loads are still 12V
- to charge a 48V lithium service bank, while driving/boating
- to charge a 12V starter battery, while connected to the grid

The Mac Plus can be used as:

- a 3-Step+ battery charger or
- a stabilized DC power supply.

The Mac Plus can only be used in installations with a negative ground.



Dimensions

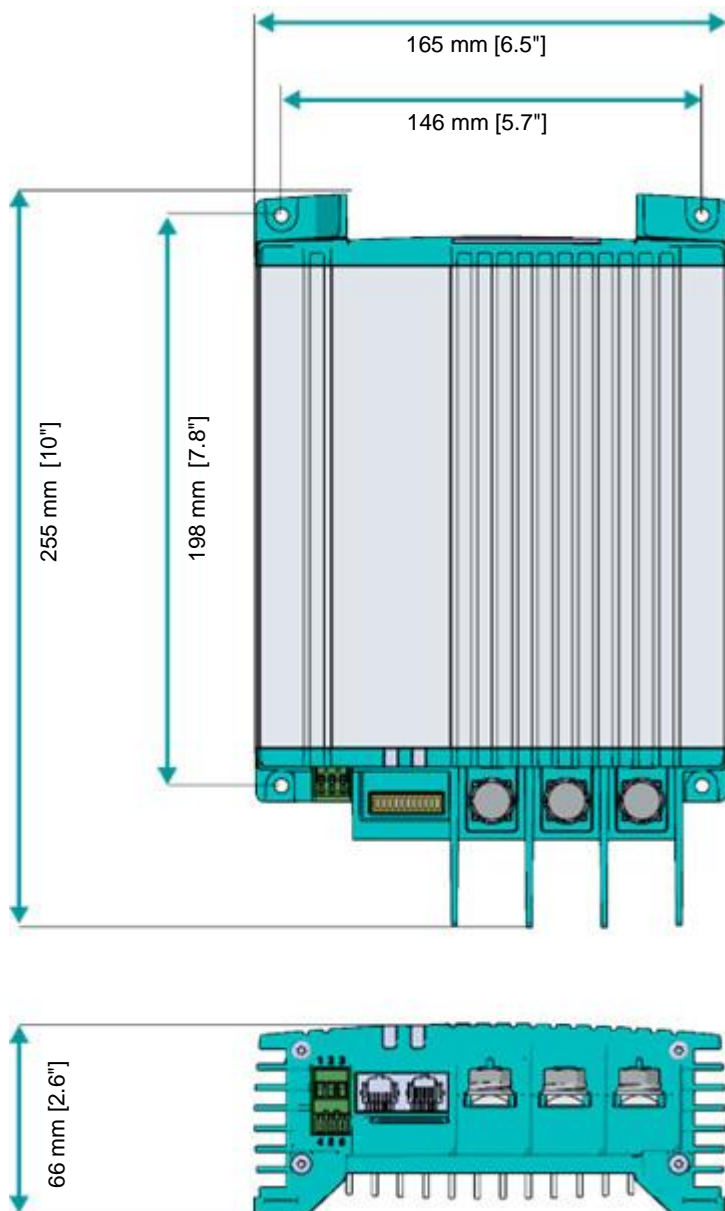

## Front panel

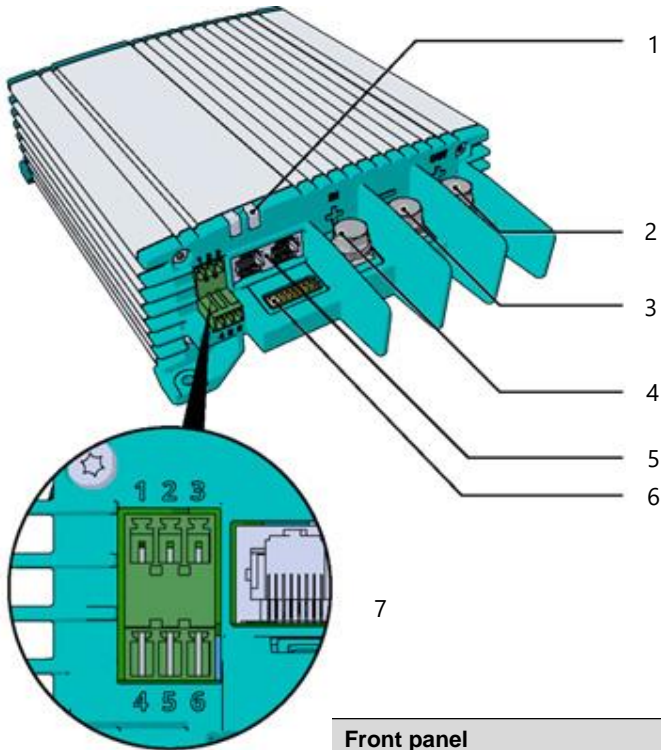

| Front panel |  |
|-------------|--|
| 1           | Status LED (2x)                            |
| 2           | + Low side (12/24V)                        |
| 3           | Ground                                     |
| 4           | + High side (36/48V)                       |
| 5           | MasterBus/CZone connection (2x)            |
| 6           | DIP switches                               |
| 7           | Accessories connector                      |
|             | Pin 1: + battery voltage sense input       |
|             | Pin 2: - battery voltage sense input       |
|             | Pin 3: change the charge direction trigger |
|             | Pin 4: remote switch input                 |
|             | Pin 5-6: battery temperature sensor input  |

## 4. Installation Instructions

In addition to the Mac Plus the delivery includes:

- Battery temperature sensor;
- Mastervolt-CZone drop cable (1m) ;
- MasterBus Terminator;
- User and installation manual.

Installation steps:

- 1 Place and mount the Mac Plus, see chapter 5;
- 2 Connect the Mac Plus, see chapter 6;
- 3 Configure the Mac Plus, see chapters 7 and 9 or 10.



### CAUTION

Read the entire manual before installing the Mac Plus. Keep the manual at a safe location for future reference.

- Operating temperature range: -20 up to +60 °C, >40 °C derating power [-4 up to +140 °F, >104 °F derating power].
- Never use the Mac Plus at a location where there is danger of gas or dust explosions.
- Mount the Mac Plus in such a way that obstruction of the airflow is prevented. This device requires a minimum of 10 cm (4") of clearance on every side.
- Do not mount the Mac Plus straight above batteries that might release corrosive sulphur fumes.
- Be sure that the output of the supplying source is switched off during installation. Also be sure that no load is connected to the batteries during installation, to prevent hazardous situations.
- Use cables with an appropriate size, see the following table.

| Recommended wire sizes DC input/output |                             |                              |
|--|-----------------------------|------------------------------|
| Model                                  | Minimum wire size high side | Minimum wire size low side * |
| 48/12-50                               | 6 mm <sup>2</sup> [AWG 9]   | 16 mm <sup>2</sup> [AWG 6]   |
| 12/48-15                               | 6 mm <sup>2</sup> [AWG 9]   | 16 mm <sup>2</sup> [AWG 6]   |
| 48/24-30                               | 6 mm <sup>2</sup> [AWG 9]   | 10 mm <sup>2</sup> [AWG 7]   |
| 24/48-15                               | 6 mm <sup>2</sup> [AWG 9]   | 10 mm <sup>2</sup> [AWG 7]   |

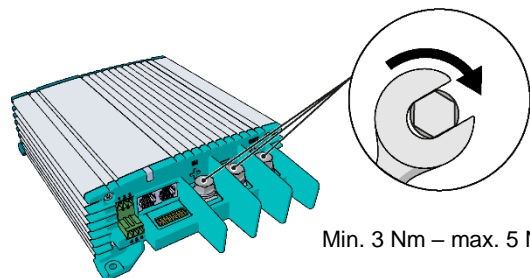

Min. 3 Nm – max. 5 Nm

\* If bi-directionality is used, both sides can be input and output. In that case, select one size bigger for the low side wire size.

## 5. Placement and Mounting

Mount the Mac Plus with four M5 screws to a solid flat surface.

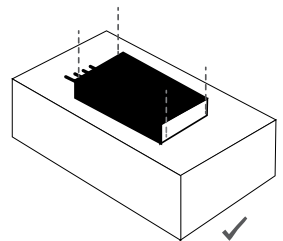
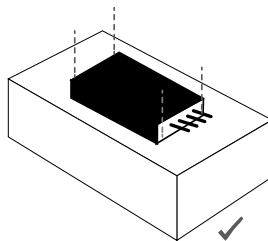
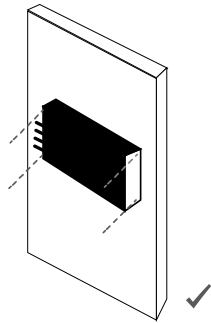
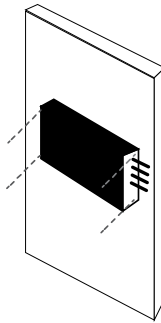
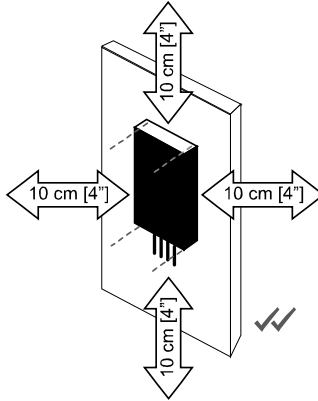
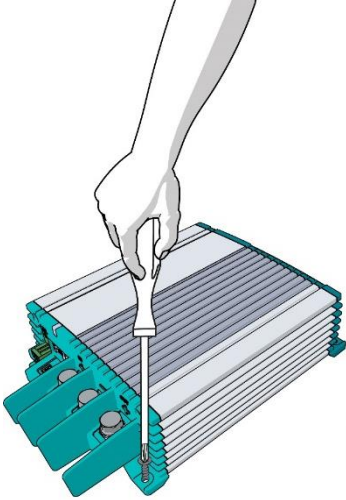

### CAUTION!

As the Mac Plus may become warm, ensure that the Mac Plus is at least 10 cm (4") away from any other objects.

## 6. Connection

Be aware that to keep the drawings clear and easy to read, cables have been drawn directly to the batteries. However, we advise to use busbars to distribute power. Busbars are not only safer, but they also make installation and maintenance easier. Use properly sized fuses and wiring!

### Installation A – the Mac Plus as a Battery charger

This schematic illustrates the general placement of a Mac Plus in a circuit.

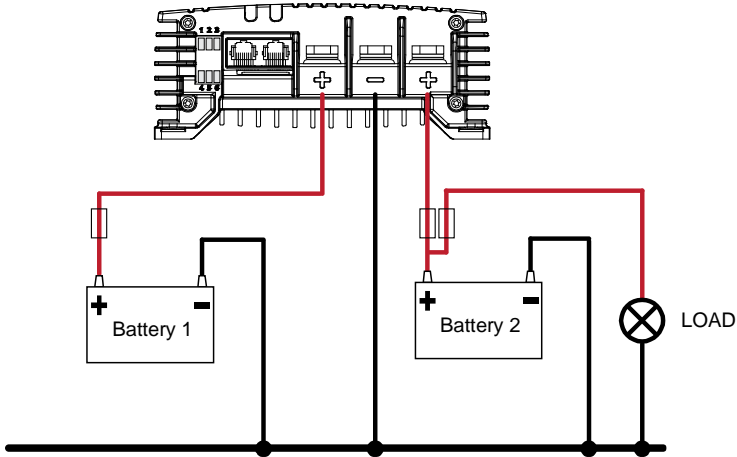

\* *Lithium-ion batteries do not require the external temperature sensor.*

### Installation B – the Mac Plus as a stabilized DC power supply

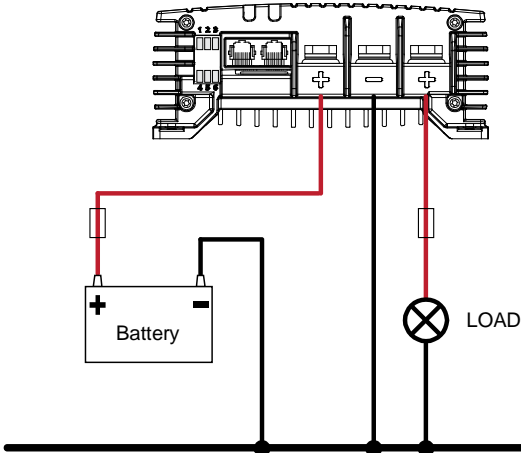

### Remote switch input (pin 4)

The Mac Plus has no on/off switch. If required, a remote switch may be used. The remote switch input (pin 4 of the Accessories connector) can be used to activate the battery charger. In a vehicle application, it is recommended to connect the engine run signal. This way, the charger is used when the engine is running and the alternator is charging. The engine run signal can be provided in different ways. Use 0.5 mm<sup>2</sup> or 0.75 mm<sup>2</sup> [18 or 20 AWG] wire for the connection. Torque: 0.34 Nm [3.0 Lb.In]. For details contact your vehicle distributor.

The remote input accepts two different enable levels:

- active low, connect to ground (between 0 and 0.5 V)
- active high, connect to + battery voltage (between 3 and 65 V)

Active low means active when input is low. Active high means active when input is high.

The remote switch input configuration can be done by DIP switch (see chapter 7) or by MasterBus (see chapter 9) or by CZone (see chapter 10).

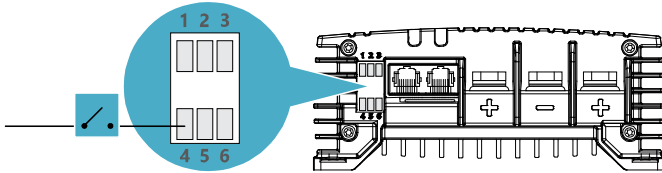

### Battery temperature sensor (pins 5 & 6)

By installing the Mastervolt battery temperature sensor (included), the charge voltages are automatically adapted for deviating temperatures. When the battery temperature is low, the charge voltage increases. In case the battery temperature is high, the charge voltage is decreased. This will extend the life of your battery.

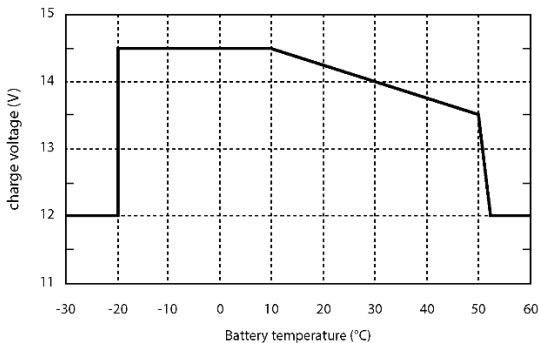

For a 24 V battery charger, multiply the voltages by two. For a 36 V charger, multiply by three. For a 48V system, multiply the voltages by four.

- Notes:**
- Temperature compensated charging does not prevent the batteries from overcharging situations.
  - Lithium-ion batteries do not require the external temperature sensor or temperature compensation!

Figure 1. Temperature compensated charging

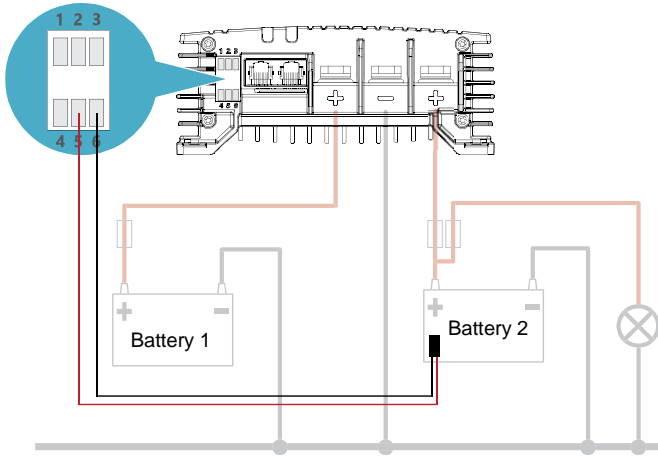

In our example, battery 2 is the service battery.

Note that temperature compensation is only supported in the default direction of the current flow.

**Voltage drop compensation (pins 1 & 2)**

The Mac Plus can compensate cable losses. For this purpose, the Mac Plus is equipped with terminals for voltage sense wires. Use 0,75 mm<sup>2</sup> [AWG 18], preferably red and black wire and protect these with 2 A fuses slow blow. Pay close attention to the polarity of the wires.

In order to accurately measure the battery voltage, connect the voltage sense wires as close to the battery poles as possible. The positive and negative voltage sense wires must be connected. Cable losses will be compensated up to a maximum of 0.55 V.

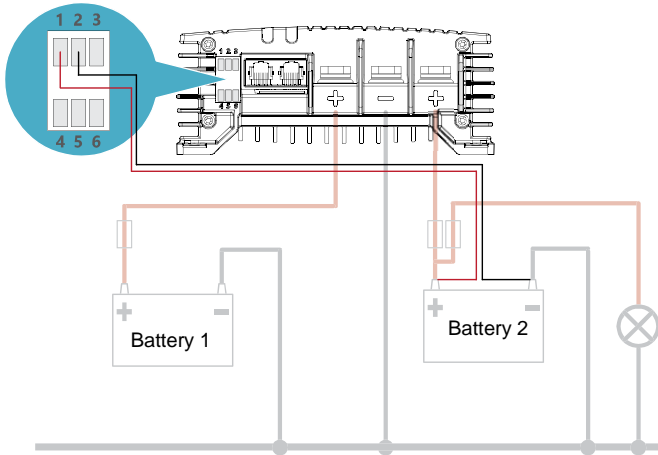

In our example, battery 2 is the service battery.

Note that voltage compensation is only supported in the default direction of the current flow.

### Optional 'reverse charge direction'-switch (pin 3)

Use pin 3 on the accessories connector, to connect a latching switch to toggle the direction of the current flow. The maximum voltage to trigger pin 3 is <math><65\text{V}</math> but the switching point is at 5V. Use 0.5 mm<sup>2</sup> or 0.75 mm<sup>2</sup> [18 or 20 AWG] wire for the connection. Torque: 0.34 Nm [3.0 Lb.In].

The active LED indicates the direction of the current flow.

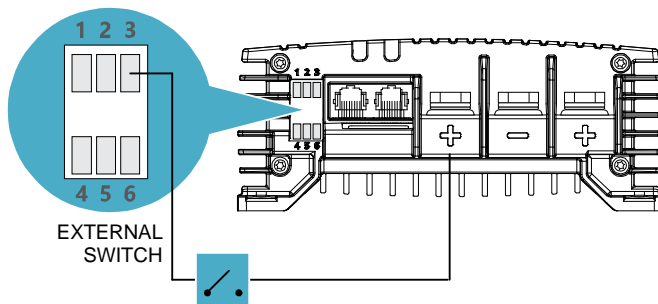

In our example, the required voltage comes from the high side. This could also come from an external source.

0 = 0-5V

1 = 5-65V

### Adding the Mac Plus to a MasterBus network

**Precondition:** This section assumes that a MasterBus network is already installed.

1. Disconnect a MasterBus cable or Terminator from the closest MasterBus device and connect it to the Mac Plus.
2. Connect the new MasterBus cable to the other MasterBus device and then connect to the Mac Plus.

### Adding the Mac Plus to a CZone network

**Precondition:** This section assumes that a CZone backbone is already installed.

1. Disconnect the backbone at the closest backbone connection and add in a tee connector.
2. Reconnect the backbone connection(s) with the new tee connector in place.
3. Connect the RJ45 Mastervolt-CZone drop cable to the black coupler on the tee and then connect to the Mac Plus.



## 7. Configuration – DIP Switches

The Mac Plus settings can be adjusted in two ways:

- By means of DIP switches;
- From a monitoring panel, for example the EasyView 5 (MasterBus) or the Touch 10 (CZone), or from a computer with MasterAdjust or the CZone Configuration Tool. Some settings can only be changed in this way.

This chapter only describes the DIP switch settings. For advanced settings in a MasterBus network, see chapter 9. For advanced settings in a CZone network, see chapter 10.



### CAUTION!

Incorrect settings of the Mac Plus can cause serious damage to your batteries and/or the connected load! Adjustments of settings may be undertaken by authorized personnel only! If the firmware of the Mac Plus requires an update, ensure that DIP switch 2 is ON.

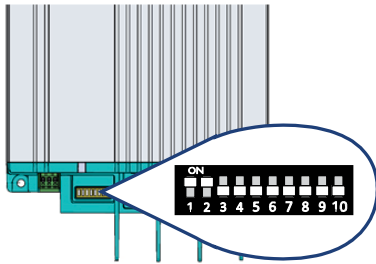

Use a small screwdriver to carefully set the required settings. You may need to remove the cables (or Terminator) to be able to access the DIP switches.

**In a CZone network**, set DIP switches 1 and 2 to OFF. DIP switches 3 to 10 must match the unique address used in the CZone network. At least one of DIP switches 3 to 10 must be ON.

**Note:** Setting all DIP switches to the OFF position will reset the Mac Plus to factory settings and erase all related settings in the configuration file.

**In a MasterBus network**, set DIP switches 1 and 2 to ON. Use the other DIP switches for charger and battery settings. For an overview of the various DIP switch settings, see the following three tables, where a 0 indicates OFF or ↓ and a 1 indicates ON or ↑.

**Note:** DIP switch settings overrule MasterBus settings. If DIP switches are not in their default setting, the corresponding MasterBus setting is grayed out.

If a DIP switch is set back to its original setting, the corresponding setting switches back to its default value. For example: in MasterAdjust, battery type Gel was selected. Then DIP switch 3 was set to ON, to select battery type MLI. When DIP switch 3 is set back to OFF, the battery type will be Flooded; the default value.

| DIP switch 1 | Communication network selection |
|--------------|---------------------------------|
| 0            | CZone                           |
| 1            | MasterBus                       |

| DIP switch 2 |  | MasterBus communication   |
|--------------|--|---|
| 0            |  | Smart on; no MasterBus communication in sleep mode (no load <2Ma)   |
| 1            |  | MasterBus communication always on, provided there is enough input power.<br>In Sleep mode, no communication <1mA<br>In Standby, but still communicating <10mA |

| DIP switch |   |   | Battery type  |
|------------|---|---|---|
| 3          | 4 | 5 |   |
| 0          | 0 | 0 | Follow MasterBus setting, see chapter 9. Default setting: Flooded battery |
| 0          | 0 | 1 | Flooded   |
| 0          | 1 | 0 | AGM   |
| 0          | 1 | 1 | Gel   |
| 1          | 0 | 0 | Lithium-Ion (MLI)   |
| 1          | 1 | 1 | Constant voltage (13.25 V*)   |

| DIP switch |   |   | Charger on conditions  | Typical use   |
|------------|---|---|--|---|
| 6          | 7 | 8 |  |   |
| 0          | 0 | 0 | MasterBus settings apply, see chapter 9.<br>Default setting: Remote switch input 'active high' and input voltage greater than enable voltage setpoint (12.50 V*) | Default setting.<br>Recommended setting for vehicle with proper engine run signal |
| 0          | 0 | 1 | Always on (Remote switch input not used)   | When the battery charger must be always active                                    |
| 0          | 1 | 0 | Remote switch input 'active low'   | Enable the battery charger by external operating signal                           |
| 0          | 1 | 1 | Remote switch input 'active high'  | Enable the battery charger by external operating signal                           |
| 1          | 0 | 0 | Remote switch input 'active low' and input voltage greater than enable voltage setpoint (12.50 V*)   | Recommended setting for vehicle with proper engine run signal                     |
| 1          | 0 | 1 | Remote switch input 'active high' and input voltage greater than enable voltage setpoint (12.50 V*)  | Recommended setting for vehicle with proper engine run signal                     |
| 1          | 1 | 0 | Input voltage greater than enable voltage setpoint (13.50 V*)<br>(Remote switch input not used)  | Higher enable voltage setpoint. Setting for vehicle without engine run signal     |

\* For a 24 V battery charger, multiply the voltages by two. For a 36 V charger, multiply by three. For a 48 V charger, multiply by four.

| DIP switch 9 |  | High side behavior                  |
|--------------|--|-------------------------------------|
| 0            |  | High side is nominal 48 V (default) |
| 1            |  | High side is nominal 36 V           |

DIP switch 10 is reserved for future use.

## 8. Operation

The Mac Plus has no on/off switch. If required, a remote switch may be used. See page 14.

### LED indicators

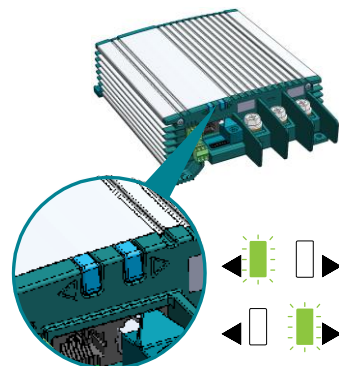

The Mac Plus features two LED indicators. Either the left arrow LED or the right arrow LED indicates the status of the Mac Plus. The active LED indicates the direction of the current flow.







This means that the high side is being charged



This means that the low side is being charged

Use the following table to understand the meaning of the LED signals.

| LED color | LED indication   | Meaning                               |  |
|-----------|--|---------------------------------------|--|
| Green     | <br>Solid           | On                                    | Normal operation.<br>The Mac Plus is in charging mode if it meets the switch-on conditions (see DIP switch/ MasterBus/CZone settings)  |
| Blue      | <br>Slow blinking   | Sleep (low no-load power consumption) | Normal operation.<br>The Mac Plus enters sleep mode when the sleep delay has passed, to reduce the no-load power consumption.<br>Every 5 seconds (configurable in a MasterBus network), the Mac Plus scans if the configured battery charger meets the switch-on conditions. |
| Blue      | <br>Solid         | Standby                               | Normal operation<br>The Mac Plus goes to standby when it does not meet the switch-on conditions (see DIP switch/MasterBus/CZone settings).<br>Or<br>Switched off by the Standby button in a MasterBus menu, or by a MasterBus event, or by a CZone circuit.                  |
| Red-Blue  | <br>Fast blinking | Software update                       | Update is in progress.   |
| Red       | <br>Solid         | Possible error                        | Analyze the situation.   |

### Operating modes

**Note:** To keep the drawings in this section easy to read, only the positive (+) cables have been drawn. The alternator could also be a charger.

- **Charger mode:** When incoming DC power is available, both batteries will be charged.

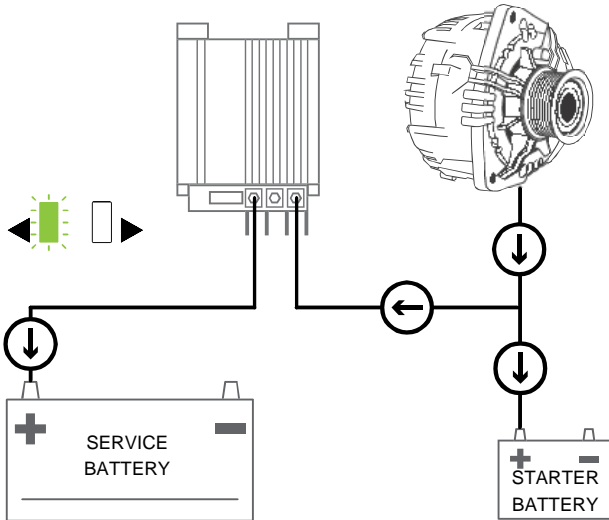

- **Bi-directional option:** If the starter battery needs to be charged, the Mac Plus can reverse the direction of the current flow.

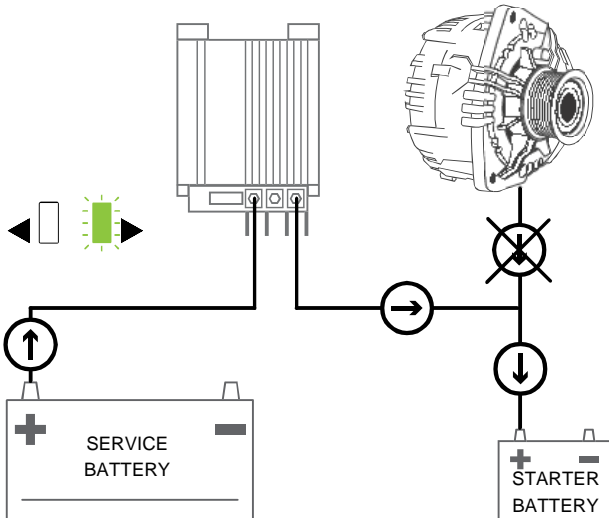

- CV (Constant Voltage) Power control mode:** When incoming DC power is limited, the Mac Plus can reduce its battery charger output. This prevents the starter battery from being drained. The power sharing level is adjustable through the “Input setpoint” setting.

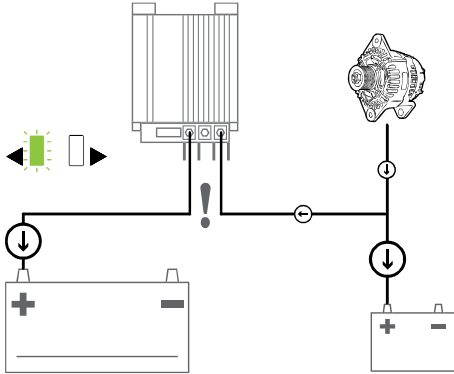

Let's assume a system with a Mac Plus 48/12-50 and a 70A alternator. Without the CV Power Control option, the voltage would drop if both batteries would pull 50A.

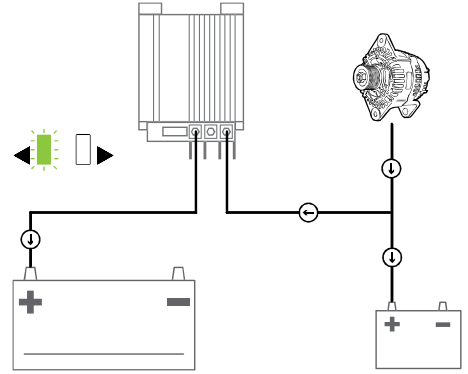

To prevent this, select the CV Power Control option. Now the Mac Plus will reduce/increase its output, thereby stabilizing the input voltage.

- Stabilized DC power supply mode:** When one side is connected to a battery and the other side is connected to a load, the Mac Plus offers a stable output.

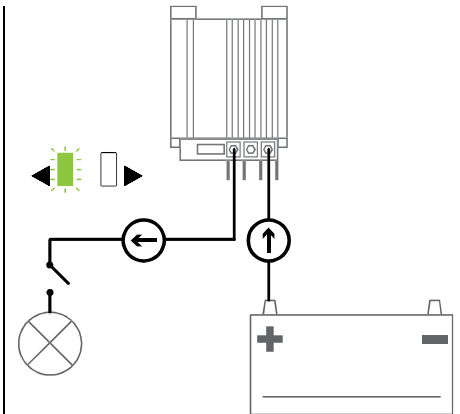
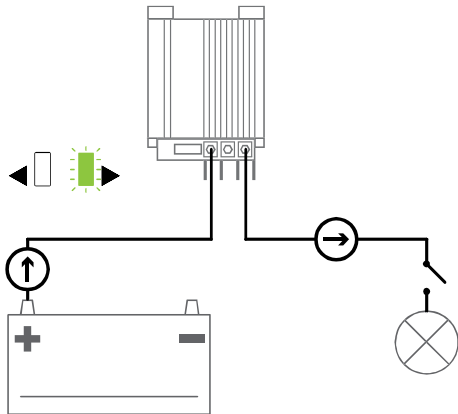

### Bi-directional operation

Reversing the charge direction can for example be used for temporarily boosting the starter battery. Selecting the direction of the current flow can be done manually or automatically. The default direction of a Mac Plus is the direction indicated by the product name. So by default, the 48/12-50 model charges the low side, while the 12/48-15 model charges the high side.

- To change the direction manually, use a latching switch that is connected to pin 3 of the accessories connector, or press a button on a display.

**Note:** if you change the direction manually, it must also be manually reset! Manual settings overrule MasterBus/CZone settings.

Button in a MasterBus network: either press the “Reversal” button on the Monitoring tab in MasterAdjust or press a “Reversal” button on a display, like the EasyView 5. Note that it is necessary to configure this button first. Please refer to the relevant user manual.

Button in a CZone network: press a “Reversal” button on a display, like the Touch 7. Note that it is necessary to configure this button first. Please refer to the relevant user manual.

- To change the direction automatically, use events in a MasterBus network or circuits in a CZone network. See chapters 9 and 10 for more information on system automation.

| Example     | Event 1 source | Event 1 target | Event 1 command | Event 1 data |
|-------------|----------------|----------------|-----------------|--------------|
| Mac Plus:   | Reversal       | Switch Input   | LED4            | Toggle       |
| EasyView 5: | Switch 6       | Mac Plus       | Reversal        | Toggle       |

Reversing the charge direction does not affect temperature or voltage drop compensation. These features will always measure the default 'output' side. For example, a Mac Plus 48/12-50 only measures the 12V side for compensation.

**Note:** this feature only works when the bi-directional option is configured.

### Flat battery support

The Mac Plus automatically detects a flat battery and will initiate the flat battery charge curve described in the following table.

| Voltage*        | Output power                        |
|-----------------|-------------------------------------|
| 0V – 8.00V      | 25% of $I_{max}$                    |
| 8.00V – 10.00V  | linear from 25% - 100% of $I_{max}$ |
| 10.00V – 14.25V | 100% of $I_{max}$                   |

\* For a 24 V battery, multiply the voltages by two. For 36 V, multiply by three. For 48V, multiply by four.

## 9. MasterBus

### What is MasterBus



All devices that are suitable for MasterBus are marked by the MasterBus symbol

MasterBus is a fully decentralized data network for communication between the different Mastervolt system devices. It is a CAN-bus based communication network.

MasterBus is used as power management system for all connected devices, such as the inverter, battery charger, generator and many more. This gives the possibility for communication between the connected devices, for instance to start the generator when the batteries are low.

MasterBus reduces complexity of electrical systems by using UTP patch cables. All system components are simply chained together. Therefore, each device is equipped with two MasterBus data ports. When two or more devices are connected to each other through these data ports, they form a local data network, called the MasterBus. The results are a reduction of material costs as only a few electrical cables are needed and less installation time.

For central monitoring and control of the connected devices Mastervolt offers a wide range of panels which show full status information of your electrical system at a glance and a push of a button. See [www.mastervolt.com](http://www.mastervolt.com) for all available options.

New devices can be added to the existing network in a very easy way by just extending the network. This gives the MasterBus network a high degree of flexibility for extended system configuration, not only today, but in the future as well!

Mastervolt also offers several interfaces, making even non-MasterBus devices suitable to operate in the MasterBus network.

### MasterBus on the Mac Plus

When the Mac Plus is connected, open MasterAdjust on a Windows computer connected to the MasterBus network via a Mastervolt USB interface. MasterAdjust software is available as free to download software on the Mastervolt website: [www.mastervolt.com](http://www.mastervolt.com).

The following tables list the parameters as shown in MasterAdjust.

## Monitoring

| Value              | Meaning  |
|--------------------|--|
| <b>Status</b>      |  |
| Device state       | Shows the actual operation mode: Standby / Charging / Alarm  |
| Charge state       | State of charge algorithm: Off / Bulk / Absorption / Float / Constant voltage / Stopped  |
| On/Standby         | Button to toggle the device state.<br><b>Note:</b> in the standby mode, the Mac Plus can be switched on again automatically. This happens, for example, after a restart.<br>In standby mode, the Mac Plus remembers its charge state for one hour. |
| Direction          | The direction of the current flow is shown when the Bi-directional option is on. For example "Charging DC 48V" means that the high side is being charged.  |
| Reversal           | Button to toggle the direction of the current flow   |
| <b>DC 36/48</b>    |  |
| High side [V]      | Voltage at the high side. This name is entered in the Configuration tab, in the DC 36/48 Name field.   |
| High side [A]      | Current of the high side*  |
| Bat. volt sense    | Battery voltage measured by the battery voltage sensor.  |
| <b>DC 12/24</b>    |  |
| Low side [V]       | Voltage at the low side. This name is entered in the Configuration tab, in the DC 12/24 Name field.  |
| Low side [A]       | Current of the low side*   |
| <b>Remote</b>      |  |
| Reverse direc.     | Checkbox that indicates the status of 'Reverse charge direction' option  |
| Remote input       | Checkbox that indicates the status of the 'Remote switch input'  |
| Remote input [V]   | Voltage at the Remote input if a signal is detected and Remote input mode (active low or active high) is configured.   |
| <b>Temperature</b> |  |
| Device             | Device temperature   |
| Battery            | Actual battery temperature measured by the Battery temperature sensor. If no battery temperature sensor is used or when Battery is set to "Li-Ion": "---" is shown.  |

\* a negative value indicates a discharge



## Alarm

| Value           | Meaning  |
|-----------------|--|
| <b>General</b>  |  |
| Dev. temp. high | Internal temperature is too high                   |
| Dev. temp. low  | Internal temperature is too low                    |
| Bat. temp. high | Battery temperature is too high (> 55 °C [131 °F]) |
| Bat. temp. low  | Battery temperature is too low (< -20 °C [-4 °F])  |
| Input high      | Input voltage is too high                          |
| Input low       | Input voltage is too low                           |
| Output high     | Output voltage is too high                         |
| Output low      | Output voltage is too low                          |
| Over vol. prot. | Over Voltage Protection shutdown                   |
| Over curr. prot | Over Current Protection shutdown                   |
| HW fault        | Internal hardware error                            |
| Cable loss high | Cable loss is too high (>2.5 V)                    |
| <b>Critical</b> |  |
| OVP HS fault    | Over Voltage Protection error on High Side         |
| OVP LS fault    | Over Voltage Protection error on Low Side          |
| OCP fault       | Over Current Protection error                      |
| NTC fault       | Temperature sensor error                           |
| EEPROM fault    | EEPROM error                                       |

## Configuration

**Note:** Settings marked with a ✖ are not available in CZone.

| Setting         | Meaning   | Factory setting        | Adjustable range |
|-----------------|---|------------------------|------------------|
| <b>Device</b>   |   |                        |                  |
| Language ✖      | Menu language of this device  | English                | EN               |
| Name            | Name of this device. This name will be recognized by all devices connected to the network | <i>Model dependent</i> | 0-12 characters  |
| CZone enabled   | This checkbox is marked when the Mac Plus is setup to work in a CZone network             | Off                    | (read only)      |
| DIP switches    | DIP switch state 0=off, 1=on  | 1100000000             | (read only)      |
| Back to default | Button to reset the Mac Plus to default settings (requires installer rights)              |                        |                  |

| Setting  | Meaning  | Factory setting        | Adjustable range                  |
|--|--|------------------------|-----------------------------------|
| Events locked  | Option to lock the events (requires installer rights)  | Off                    | On, Off                           |
| <b>Processor</b>   |  |                        |                                   |
| Version  | Firmware main version  |                        | (read only)                       |
| Revision   | Product version  |                        | (read only)                       |
| Bootloader ver.  | Firmware bootloader version  |                        | (read only)                       |
| <b>Direction config</b> (you need to login as installer to see the following parameters) |  |                        |                                   |
| Bi-directional   | Option to enable bi-directional operation and the following fields<br>From the <b>Configure</b> drop-down list, select the first side that you want to configure. After completing all relevant fields, select the other side and continue | Off                    | On, Off                           |
| Configure  | Select which side to configure.  | <i>Model dependent</i> | Charging DC 12V*                  |
| <b>DC 36/48V</b> (high side)   |  |                        |                                   |
| Name   | Name of the high side. This name will be used for monitoring.  | <i>Model dependent</i> | 0-12 characters                   |
| 36V  | High side is nominal 36 V  | Off                    | On, Off                           |
| <b>DC 12/24V</b> (low side)  |  |                        |                                   |
| Name   | Name of the low side. This name will be used for monitoring.   | <i>Model dependent</i> | 0-12 characters                   |
| <b>Remote input</b>  |  |                        |                                   |
| Mode   | Active low: active when the input voltage is 0 - 0.5 V<br>Active high: active when the input voltage is 3 - 65 V<br>Not used: always active (depending on input threshold)   | Active high            | Not used, Active low, Active high |
| <b>Input threshold</b>   |  |                        |                                   |
| Enabled  | Disabled: input voltage thresholds are not active<br>Enabled: input voltage thresholds are active and the following field can be edited  | Enabled                | Enabled, Disabled                 |
| Enable voltage   | Enable input voltage   | 12.50 V*               | 8-16 V*                           |
| Enable delay   | Enable delay   | 2 s                    | 0-300 s                           |
| Disable voltage  | Disable input voltage  | 12.00 V*               | 8-16 V*                           |
| Disable delay  | Disable delay  | 300 s                  | 0-300 s                           |
| Instant disable  | Disable input voltage, no delay  | 11.00 V*               | 8-16 V*                           |
| Sleep delay  | Delay before the Mac Plus switches to sleep mode   | 300 s                  | 0-3600 s                          |

| Setting            | Meaning   | Factory setting        | Adjustable range                             |
|--------------------|---|------------------------|--|
| Sleep duration ✕   | Select how long the Mac Plus will be inactive. A higher duration results in lower consumption.  | 5 sec.                 | 1, 2, 5, 10, 20 seconds                      |
| <b>Charger</b>     |   |                        |  |
| Method             | Charge method   | 3-Step+                | 3-Step+ (IUoU), Constant voltage             |
| Battery type**     | Selection of pre-set charge settings for 3-Step+ method. Individual adjustments are only possible if “User defined” is selected here.   | Flooded                | Flooded, Gel, AGM, Lithium-ion, User defined |
| Output voltage     | Output voltage for Constant voltage method.   | 13.25 V                | 8-15 V*                                      |
| Max output (limit) | Maximum output (charge) current   | 50 A / 30 A            | 0-50 A / 0-30 A                              |
| Max input (limit)  | Maximum input current   | 50 A / 30 A            | 0-50 A / 0-30 A                              |
| Current ramp up ✕  | Charge current ramp up after enabling the charger.  | 5 A/s                  | 0-50 A/s                                     |
| CV Power Control   | In situations where the input voltage is limited, Constant Voltage (CV) Power Control may be desirable. This enables the Mac Plus to charge the service battery, while keeping the starter battery charged sufficiently. This is done by reducing the output of the Mac Plus. | Off                    | On, off                                      |
| Input setpoint     | Sets the level at which the Mac Plus maintains its constant voltage if the CV Power Control option is enabled. This level needs to be chosen such that it will not overcharge or discharge the battery, but a bit lower than the alternator setpoint.                         | <i>Model dependent</i> | 32-64 V                                      |
| Temp. compensate   | Temperature compensation for charge voltage   | -0.030 V/°C            | -0.1 - +0.1 V                                |
| <b>Bulk</b>        |   |                        |  |
| Bulk voltage       | Bulk voltage  | 14.25 V*               | 8-15 V*                                      |
| Max bulk time      | Maximum bulk time   | 480 min                | 0-1440 min                                   |
| Min bulk time      | Minimum bulk time   | 120 s                  | 0-240 s                                      |
| Start bulk time    | Start bulk timer  | 13.25 V*               | 8-15 V*                                      |

| Setting                 | Meaning   | Factory setting        | Adjustable range    |
|-------------------------|---|------------------------|---------------------|
| <b>Absorption</b>       |   |                        |                     |
| Abs. voltage            | Absorption voltage  | 14.25 V*               | 8-15 V*             |
| Max absorp. time        | Maximum absorption time   | 240 min                | 0-1440 min          |
| Min absorp. time        | Minimum absorption time   | 15 min                 | 0-240 min           |
| Return amps (A)         | If the charge current drops below this level, the charger switches from the Absorption to the Float stage (% of $I_{max}$ ) | <i>Model dependent</i> | 0-50 % of $I_{max}$ |
| <b>Float</b>            |   |                        |                     |
| Float voltage           | Float voltage   | 13.25 V*               | 8-15 V*             |
| Bulk ret. volt          | Return to bulk voltage  | 12.80 V*               | 8-15 V*             |
| Bulk return time        | Return to bulk time delay   | 30 s                   | 0-240 s             |
| <b>Constant voltage</b> |   |                        |                     |
| Constant voltage        | Constant output voltage   | 13.25 V*               | 8-15 V*             |
| <b>Input alarm</b>      |   |                        |                     |
| Configure               | Option to set the following thresholds  | Off                    | Off, on             |
| High alarm on           | High input voltage alarm on   | 16.00 V*               | 8-16 V*             |
| High alarm off          | High input voltage alarm off  | 15.50 V*               | 8-16 V*             |
| Low alarm off           | Low input voltage alarm off   | 11.00 V*               | 8-16 V*             |
| Low alarm on            | Low input voltage alarm on  | 10.00 V*               | 8-16 V*             |
| Low alarm delay         | Low input alarm delay time  | 5 s                    | 0-300 s             |
| <b>Output alarm</b>     |   |                        |                     |
| Configure               | Option to set the following thresholds  | Off                    | Off, on             |
| High alarm on           | High output voltage alarm on  | 15.25 V*               | 8-16 V*             |
| High alarm off          | High output voltage alarm off   | 14.75 V*               | 8-16 V*             |
| Low alarm off           | Low output voltage alarm off  | 11.00 V*               | 8-16 V*             |
| Low alarm on            | Low output voltage alarm on   | 10.00 V*               | 8-16 V*             |
| Low alarm delay         | Low output alarm delay time   | 30 s                   | 0-300 s             |

\* For a 24 V battery charger, multiply the voltages by two. For a 36 V charger, multiply by three. For a 48 V charger, multiply by four.

\*\* For an overview of charging specification, see section "Battery settings" on page 38.

## Events

A MasterBus device can be programmed to initiate an action at another connected device. This is very helpful in automation of your system but is not required. In MasterBus this is done by means of event-based commands. In the Events tab you can program the Mac Plus to act as an event source. Events which occur during the operation of the Mac Plus will then trigger actions from other products.

| Field           | Meaning   | Value                                   |
|-----------------|---|---|
| Event x source  | Select an event that triggers an action, for example Battery pre low.                 | See <i>Event source</i> list            |
| Event x target  | Select the device that should take action, for example the generator                  | Selectable targets are system dependent |
| Event x command | Select the parameter that must be changed on the target device, for example Activate. | See command list of the selected device |
| Event x data    | Data translates the input into an output.   | Off, On, Copy, Copy Invert, Toggle      |

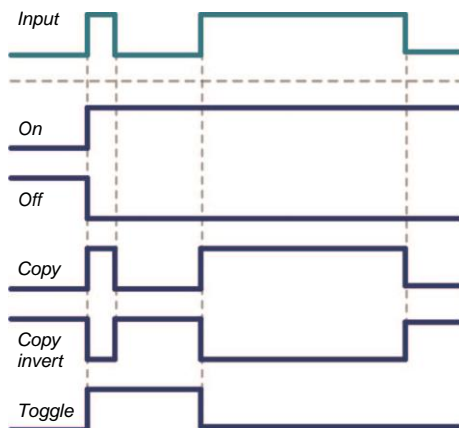

- On: status changes to On at first input signal.
- Off: status changes to Off at first input signal.
- Copy: status follows input signal.
- Copy invert: status follows opposite of input.
- Toggle: status changes at 1<sup>st</sup> signal and back at the 2<sup>nd</sup>.

The Mac Plus can be configured as an *event source*. An event source can be used to initiate an *event command* and an *event action* by another device.

| Event source | Meaning                                   |
|--------------|---|
| Standby      | Device state is Standby                   |
| Bulk         | State of charge is Bulk                   |
| Absorption   | State of charge is Absorption             |
| Float        | State of charge is Float                  |
| Alarm        | Any of the alarms is triggered            |
| Reversal     | Direction of the current flow is reversed |
| Sleep        | Device state is Sleep                     |

When the Mac Plus is configured as an *event target* by another device, this device can initiate an *event command* and an *event action* to be performed by the Mac Plus.

| Event command | Meaning   |
|---------------|---|
| Standby       | Command to switch on/off the Mac Plus. If the Mac Plus was switched off by means of this event command, it will switch on again when it wakes from sleep mode (i.e. after meeting the switch-on conditions, see DIP switch/MasterBus settings). |
| Bulk          | Command to start the Bulk state of charge   |
| Absorption    | Command to start the Absorption state of charge   |
| Float         | Command to start the Float state of charge  |
| Reversal      | Command to reverse the direction of the current flow  |
| Sleep         | Command to put the Mac Plus to sleep mode   |
| Stop Charge   | Command to stop charging the battery  |

## 10. CZone

### What is CZone

The CZone® network is an NMEA 2000-compliant CAN-based system. Either do the configuration while connected to the network or use a prepared configuration file (.zcf). Ensure that a DIP Switch is assigned.

### Adding the Mac Plus to a CZone system configuration

**Precondition:** This section assumes that a CZone system is already configured and the CZone Configuration Tool is open.

1. In the CZone Configuration Tool, from the **Modules** tab, press the **Add** button.

DC/DC Converter Configuration

Module Name:  
Mac Plus

Module Type:  
DC/DC Converter (DC/DC)

Dipswitch Setting:  
10000000 (Available)

Auto-Select First Detected Module

Charger Type:  
Mac Plus 48/12-50(IP23) (81203105)

DC/DC :

Bi-Directional

Nominal Voltage:  
48V

Battery Type (12V):  
Flooded

Current Limit:  
50 A

Battery Type (48V):  
Flooded

Current Limit:  
15 A

Switched Module/Network Power

Advanced Settings

Alarm/Switch Settings

OK Cancel

2. From the **Module Type** drop-down list select **DC/DC Converters**.
3. From the **Charger Type** drop-down list select the required Mac Plus model.
4. Enter an understandable **Module Name**.
5. Select **Bi-Directional** to enable bi-directional operation.
6. Select the **Battery Type** (Flooded, Gel, AGM, Lithium-Ion, or User defined).  
For an overview of charging specification, see section "Battery settings" on page 38.
7. Each device on a CZone network has a unique CZone address, the **Dipswitch**. This number must match the physical DIP switch settings. When connected to the system: either select one from the drop-down list or edit graphically.
8. Press the **Advanced Settings** button to configure advanced options.

Note that only when the Bi-Directional option is selected, there will be two tabs. One for the high side (36/48V) and one for the low side (12/24V). Each with the same settings.

MacPlus Advanced Settings

Mac Plus:

Charging DC 48V | Charging DC 12V

**General:**

Charge Method:  
3-Step+(UoU)

**DC:**

NMEA2000 DC Instance:  
2

Name:  
High side

Maximum Input Current:  
60 A

**Remote Input:**

Mode:  
Active High

**Input Threshold**

Enable Threshold

Enable Voltage: 12.50 V | Enable Delay: 2 Sec

Disable Voltage: 12.00 V | Disable Delay: 300 Sec

Instant Disable: 11.00 V | Sleep Delay: 300 Sec

**Bulk Settings:**

Voltage: 57.00 V

Minimum Timer: 2 Minutes

Maximum Timer: 480 Minutes

Start Timer At: 53.00 V

**Absorption Settings:**

Voltage: 57.00 V

Minimum Timer: 15 Minutes

Maximum Timer: 240 Minutes

Battery Full Current: 1 A

**Float Settings:**

Voltage: 53.00 V

Return to Bulk Timer: 30 Seconds

Return to Bulk Voltage: 51.20 V

CV Power Control

Input setpoint: 13.25 V

Note: Greyed out items can only be edited for USER DEFINED battery type except Input Threshold.

OK | Cancel

9. For battery types other than "User defined":
  - Select the **Charge Method** (3-Step+, or Constant voltage).
  - NMEA2000 Instances are used to differentiate between multiple monitoring sources. PGNs are identifiers for information that follows. See page 38 for an overview of supported PGNs.
  - Enter a **Name**.
  - Enter the **Maximum input Current**.
  - From the **Remote Input, Mode** drop-down list, select the required enable level:
    - o Active low: active when the input voltage is 0 - 0.5 V
    - o Active high: active when the input voltage is 3 - 32 V
    - o Off: always active
  - Select **Enable Threshold** if you want to change the settings.

For battery type "User defined", also the bulk, absorption and float settings can be adjusted.
10. Press **OK** to return to the Module Modification window and press the **Alarm/Switch Settings** button.



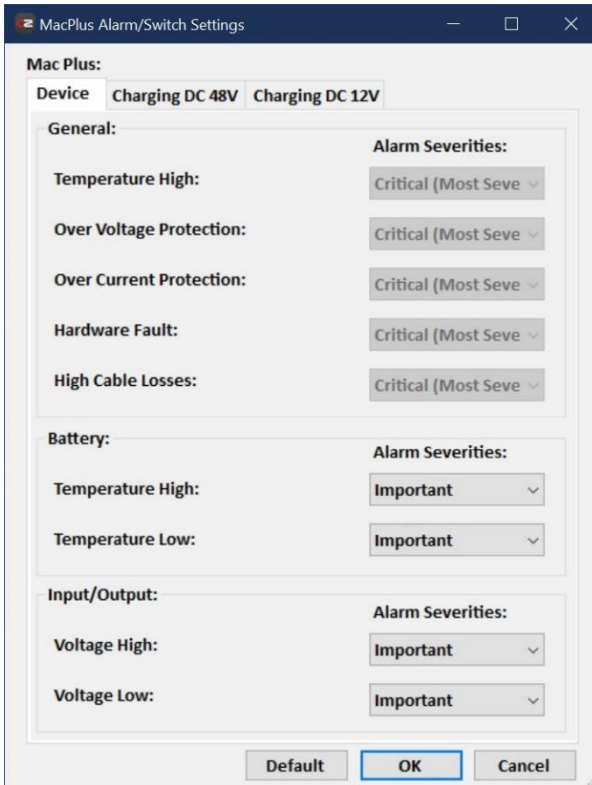

MacPlus Alarm/Switch Settings

Mac Plus:

Device: Charging DC 48V | Charging DC 12V

General:

Temperature High: Critical (Most Seve)

Over Voltage Protection: Critical (Most Seve)

Over Current Protection: Critical (Most Seve)

Hardware Fault: Critical (Most Seve)

High Cable Losses: Critical (Most Seve)

Battery:

Temperature High: Important

Temperature Low: Important

Input/Output:

Voltage High: Important

Voltage Low: Important

Default | **OK** | Cancel

11. Select the required Alarm Severities and levels.
12. Press **OK**.
13. Option: Press the **Circuits** tab to **Add** a new circuit (bottom left). For example, a stop charge switch that switches off the Mac Plus when a battery charger comes on.

By default, two circuits will be created. One for on/off, and one to toggle the direction of the current flow.

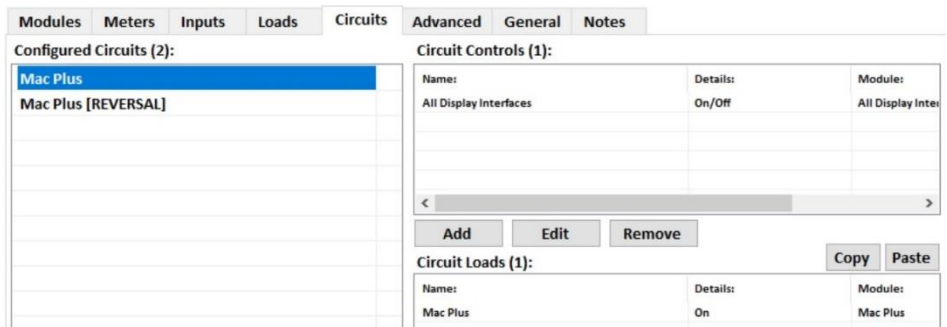

Modules | Meters | Inputs | Loads | **Circuits** | Advanced | General | Notes

Configured Circuits (2):

|                     |
|---------------------|
| Mac Plus            |
| Mac Plus [REVERSAL] |
|                     |
|                     |
|                     |
|                     |
|                     |
|                     |

Circuit Controls (1):

| Name:                  | Details: | Module:           |
|------------------------|----------|-------------------|
| All Display Interfaces | On/Off   | All Display Inter |
|                        |          |                   |
|                        |          |                   |

< | >

Add | Edit | Remove

Circuit Loads (1):

| Names:   | Details: | Module:  |
|----------|----------|----------|
| Mac Plus | On       | Mac Plus |

Copy | Paste

- **Input/Throws** (switch configuration) can be Standby, Bulk, Absorption, Float or Alarm.
  - **State** (circuit load configuration) can be On, Off, Bulk, Absorption or Float.
14. Click **OK** to close the Circuit Load Configuration window
  15. Write the configuration to the network to use the new configuration.



For more information, please refer to the CZone® Configuration Tool Instruction manual. Also see chapter 9 for a description of the same settings in MasterAdjust.

## 11. Trouble Shooting

| Malfunction  | Possible cause   | What to do   |
|--|--|--|
| No output voltage and/or current                         | No input voltage   | Check wiring   |
|  | Input voltage too low  | Check input voltage, check configuration   |
|  | No enable signal on the remote switch input                                | Check remote switch input  |
|  | The primary (input) battery is discharged too far                          | Charge input battery   |
| LED is red   | See chapter 8 for an overview of messages indicated by the LEDs.           |  |
| Output voltage too low, charger supplies maximum current | Load connected to the batteries is larger than battery charger can supply. | Reduce load taken from the batteries.  |
|  | Batteries not 100% charged   | Measure battery voltage. After some time, this will be higher.   |
|  | Wrong setting of the charge voltage  | Check settings   |
| Charge current too low                                   | Batteries almost fully charged   | Nothing, this is normal when the battery is almost fully charged.  |
|  | High ambient temperature   | Nothing; if ambient temperature is more than the setting limit, the charge current is automatically reduced. |
| Batteries not fully charged                              | Charge current too low   | See “Charge current too low” in this table.  |
|  | Current to load is too high  | Reduce load taken from the batteries.  |
|  | Charge time too short  | Use a battery charger with higher capacity.  |
|  | Battery temperature too low  | Use the battery temperature sensor to adapt charge voltage to deviating temperatures.                        |
|  | Defective or old battery   | Check battery and replace if necessary.  |
|  | Wrong setting of the charge voltage  | Check settings   |
| Batteries are discharged too fast                        | Battery capacity reduced due to wastage or sulphation, stagnation          | Charge and recharge a few times, this might help.<br>Check battery and replace if necessary.                 |
|  | Defective battery (short circuit in cell)                                  | Check battery and replace if necessary.  |
| Batteries are too warm, gassing                          | Battery temperature too high   | Use the battery temperature sensor to adapt charge voltage to deviating temperatures.                        |
|  | Charge voltage too high  | Check settings   |

| <b>Malfunction</b>                     | <b>Possible cause</b>                                    | <b>What to do</b>   |
|--|--|---|
| Slow or no MasterBus communication.    | Error in the MasterBus wiring.                           | Check the MasterBus cables.   |
|  | No terminating device placed at the ends of the network. | MasterBus needs a terminating device on both ends of the network. Check if connected. |
|  | MasterBus network is configured as a ring network.       | Ring networks are not allowed. Check the connections of the network.                  |
| Remote panel display shows no Mac Plus | Display is switched off                                  | Switch on display, refer to display manual  |
|  | Error in the wiring                                      | Check the network cables  |
|  | No terminating device placed at the ends of the network  | A network needs a terminating device on both ends of the network, check if available  |
|  | Network is configured as a ring network                  | Ring networks are not allowed. Check the connections of the network.                  |
|  | Mac Plus is not configured in CZone configuration file   | Open CZone Configuration Tool and check.  |
|  | Mac Plus Dipswitch incorrect                             | Open CZone Configuration Tool and check with Force Dipswitch for Address.             |

## 12. Technical Specifications

### Mac Plus Specifications

|   | Mac Plus<br>48/12-50  | Mac Plus<br>12/48-15 | Mac Plus<br>48/24-30 | Mac Plus<br>24/48-15 |
|---|---|----------------------|----------------------|----------------------|
| Product code                            | 81203105  | 81203205             | 81203305             | 81203405             |
| <b>Input specifications – High side</b> |   |                      |                      |                      |
| Nominal input voltage                   | 36/48 VDC   | 12 VDC               | 36/48 VDC            | 24 VDC               |
| Input voltage range                     | 32-64 VDC   | 8-16 VDC             | 32-64 VDC            | 16-32 VDC            |
| Maximum input current                   | 25 A  | 60 A                 | 25 A                 | 50 A                 |
| No load consumption                     | < 10 mA communicating, < 1 mA in sleep  |                      |                      |                      |
| <b>Output specifications – Low side</b> |   |                      |                      |                      |
| Nominal output voltage                  | 12 VDC  | 36/48 VDC            | 24 VDC               | 36/48 VDC            |
| Output voltage range                    | 10-15 V   | 30-60 V              | 20-30 V              | 30-60 V              |
| Max output current                      | 50 A  | 15 A                 | 30 A                 | 15 A                 |
| Nominal output power                    | 710 W   | 850 W                | 850 W                | 850 W                |
| Maximum output power                    | 750 W   | 900 W                | 900 W                | 900 W                |
| Flat battery charge                     | Yes, reduced (25%) charge current at low (0-8 V) battery voltage, then ramp up to 100% charge current |                      |                      |                      |
| Protection against overload             | Yes   |                      |                      |                      |
| Reverse polarity protection             | Yes, internally fused, non-replaceable  |                      |                      |                      |
| Charge characteristic                   | Mastervolt 3-Step+ algorithm  |                      |                      |                      |
| Bi-directional control                  | Yes, through MasterBus, CZone, or remote switch   |                      |                      |                      |
| Battery types                           | Flooded, Lithium-Ion (MLI), Gel, AGM, Constant voltage, User defined                                  |                      |                      |                      |

| <b>General specifications</b>       |  |
|-------------------------------------|--|
| Galvanic isolation                  | No   |
| Efficiency                          | > 95% at full output   |
| Ignition protected                  | Yes, conforming to SAE J1171/ISO 8846                              |
| Protection against over-temperature | Yes, by derating   |
| Weight                              | 2 kg [4.4 lb]  |
| Dimensions, hwxwd                   | 255x165x66 mm [10.0x6.5x5.6 inch]                                  |
| Cooling                             | Natural cooling  |
| IP rating                           | IP23   |
| Parallel configuration              | Yes  |
| Connection in- and output           | M8 screw terminal, wire size 10 to 50 mm <sup>2</sup> [AWG 0 to 8] |
| MasterBus connectivity              | Yes (not powering)   |

| General specifications                           |  |
|--|--|
| CZone connectivity                               | Yes  |
| Battery temperature sense                        | Yes, sensor included   |
| Battery voltage sense                            | Yes  |
| Remote switch input<br>(Engine run signal input) | Yes (active high / active low)   |
| DIP switches                                     | Yes, for basic setup   |
| LED  | Yes, 2x three-color LED  |
| Operating temperature range                      | -25 up to +60 °C, >40 °C derating power<br>[-13 up to +140 °F, >104 °F derating power] |
| Approvals  | CE, E-Mark, SAE J1171 & ISO 8846 Ignition Protected, FCC                               |

### CZone specifications

LEN (Load Equivalence Number): 0

PGNs (Parameter Group Numbers):

| PGN    | Description                           |
|--------|---------------------------------------|
| 127506 | DC_Detailed_Status (SOC not included) |
| 127507 | Charger Status                        |
| 127508 | Battery Status                        |

### Battery settings

**Note:** the following charge specifications are based on Mastervolt batteries. Specifications for a given chemistry of a different manufacturer may vary. If connecting batteries of a different manufacturer, make sure the manufacturer's recommendations are met. Select *User defined* to be able to adjust the battery settings in either MasterAdjust or in the CZone Configuration Tool.

| Charging specifications           | Battery type           |                        |                        |
|-----------------------------------|------------------------|------------------------|------------------------|
|                                   | Flooded (default)      | Gel / AGM              | Li-Ion (MLI)           |
| Bulk voltage                      | 14.25 V*               | 14.25 V*               | 14.25 V*               |
| Max bulk time                     | 480 min                | 480 min                | 480 min                |
| Min bulk time                     | 120 s                  | 120 s                  | 120 s                  |
| Start bulk time                   | 13.25 V*               | 13.25 V*               | 13.25 V*               |
| Return to bulk voltage            | 12.80 V*               | 12.80 V*               | 13.25 V*               |
| Return to bulk time               | 30 s                   | 30 s                   | 240 s                  |
| Absorption voltage                | 14.25 V*               | 14.25 V*               | 14.25 V*               |
| Max absorption time               | 240 min                | 240 min                | 240 min                |
| Min absorption time               | 15 min                 | 15 min                 | 15 min                 |
| Return amps(battery full current) | 6.0 % I <sub>MAX</sub> | 6.0 % I <sub>MAX</sub> | 6.0 % I <sub>MAX</sub> |
| Float voltage                     | 13.25 V*               | 13.80 V*               | 13.50 V*               |

\* For a 24 V battery charger, multiply the voltages by two. For a 36 V charger, multiply by three. For a 48V system, multiply the voltages by four.

Characteristics

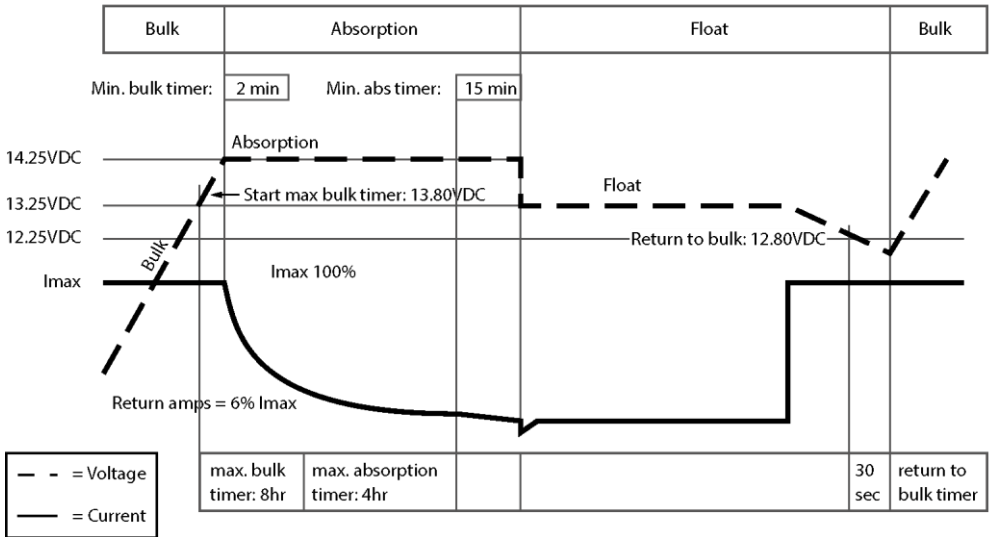

Figure 2. Typical charge characteristic (at 25°C / 77°F).  
 For a 24 V battery charger, multiply the voltages by two. For a 36 V charger, multiply by three.  
 For a 48 V charger, multiply by four.



### **Europe, Middle East & Africa**

#### **Technical Support**

T: +31 (0) 20 34 22 100

E: [ts.emea@OneASG.com](mailto:ts.emea@OneASG.com)

#### **Location & Shipping**

Navico Group EMEA

Snijdersbergweg 93

1105 AN Amsterdam

The Netherlands

### **Americas & Caribbean**

#### **Technical Support**

T: +1 262 293 0600 / 800 307 6702

E: [tech.mastervolt@OneASG.com](mailto:tech.mastervolt@OneASG.com)

#### **Location & Shipping**

Navico Group US

N85 W12545 Westbrook Crossing

Menomonee Falls, WI 53051

United States

### **Asia Pacific**

#### **Technical Support**

T: +64 9 415 7261

E: [technical.apac@OneASG.com](mailto:technical.apac@OneASG.com)

#### **Location & Shipping**

Navico Group APAC

42 Apollo Drive

Rosedale, Auckland 0632

New Zealand

*Document version: 10000021286/02 (October 23)*

*Copyright ©2023 Navico Group EMEA B.V. All rights reserved.*